

CATALOGO TECNICO COASSIALE INOX - INOX

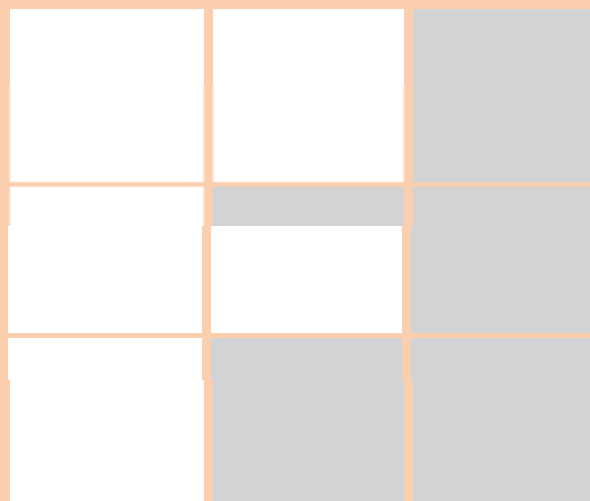



TRIVENETA FUMI





ELEMENTO LINEARE H=1000

FOTO	DISEGNO	Di	De	HT	H		
Fig. 001 		80	130	1000	940		
		100	150	1000	940		

ELEMENTO LINEARE H=500

FOTO	DISEGNO	Di	De	HT	H		
Fig. 003 		80	130	500	440		
		100	150	500	440		

ELEMENTO LINEARE H=250

FOTO	DISEGNO	Di	De	HT	H		
Fig. 005 		80	130	250	190		
		100	150	250	190		

ELEMENTO TELESCOPICO

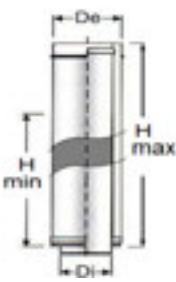
FOTO	DISEGNO	Di	De	H Min	H Max		
Fig. 008 		80	130	340	550		
		100	150	340	550		

ELEMENTO DI ISPEZIONE

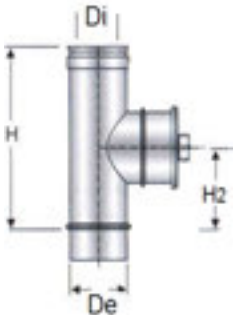
FOTO	DISEGNO	Di	De	H	H 2		
Fig. 019 		80	130	190	65		
		100	150	270	110		

ELEMENTO A "T" 90 RID. 80 FUMI

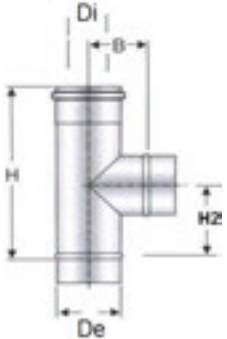
FOTO	DISEGNO	Di	De	H	H 2	B	
Fig. 010 		80	130	190	65	85	
		100	150	190	65	95	

ELEMENTO A "T" 90 RID. 80 ARIA

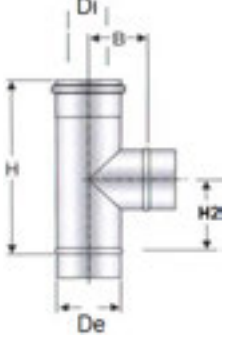
FOTO	DISEGNO	Di	De	H	H 2	B	
Fig. 011 		80	130	190	65	85	
		100	150	190	65	95	

ELEMENTO A "T" 90 STACCO COAX

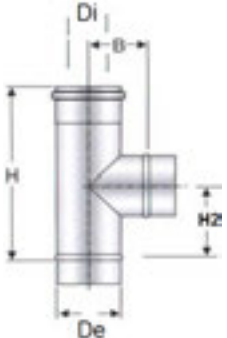
FOTO	DISEGNO	Di	De	H	H 2	B	
Fig. 015 		80	130	270	105	85	
		100	150	270	105	95	

ELEMENTO A "T" 90 RID. 80 FUMI + ARIA SX

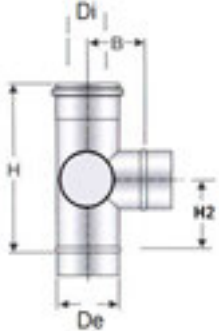
FOTO	DISEGNO	Di	De	H	H2	B	interasse
Fig. 014 		80	130	190	65	85	125
		100	150	190	65	95	125

ELEMENTO A "T" 90 RID. 80 FUMI + ARIA DX

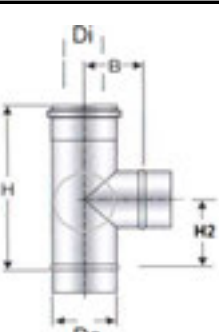
FOTO	DISEGNO	Di	De	H	H2	B	interasse
Fig. 013 		80	130	190	65	85	125
		100	150	190	65	95	125

ELEMENTO A "T" 90 STACCO 130 VENTILAZIONE

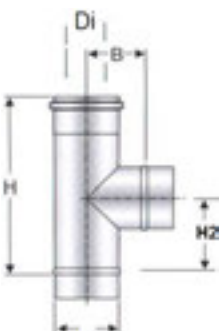
FOTO	DISEGNO	Di	De	H	H2	B
Fig. 017 		80	130	270	105	85
		100	150	270	105	95



GRIGLIA DI VENTILAZIONE

FOTO	DISEGNO	Per Diametro	De			
Fig. 021 		80	130			
		100	150			

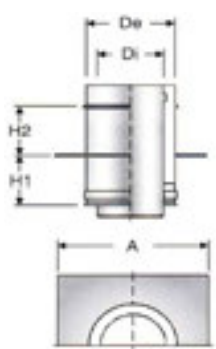

PIASTRA DI SUPPORTO INTERMEDIA

FOTO	DISEGNO	Di	De	H1	H2	A
Fig. 030 		80	130	40	85	230
		100	150	40	85	250

COPPIA ALETTE PER PIASTRA DI SUPPORTO INTERMEDIO

FOTO	DISEGNO	Per Diametro	x De	L		
DPIIF026_ _ _ 		80	130	230		
		100	150	250		

TAPPO DOPPIO SCARICO CONDENSA

FOTO	DISEGNO	Di	De	HU		
Fig. 020 		80	100	20		
		100	150	20		

CURVA A 45°

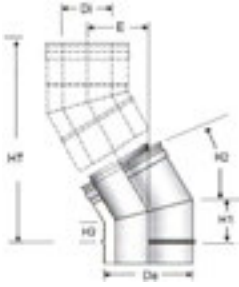
FOTO	DISEGNO	Di	De	H1	H2	H3	HT	E
Fig. 007 		80	130	70	130	20	250	100
		100	150	80	140	20	290	115

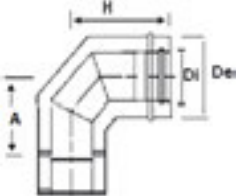

CURVA A 90°

FOTO	DISEGNO	Di	De	H	A	spost. asse 2x90°
Fig. 009 		80	130	170	120	290
		100	150	180	130	300

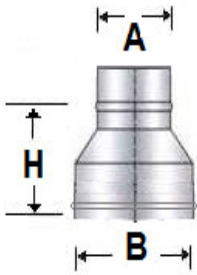
RACCORDO TERMINALE DI CHIUSURA

FOTO	DISEGNO	A= M o F	B= Di	B= De	H
SCIIF039 ___ 		80	80	130	130
		100	100	150	130

TERMINALE ANTIVENTO

FOTO	DISEGNO	Di	De	H	A	
Fig. 022 		80	130	400	200	
		100	150	400	220	

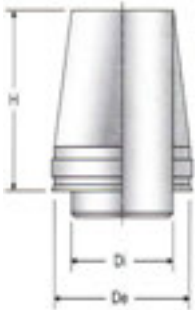

TERMINALE ANTIVENTO

FOTO	DISEGNO	Di	De	H		
Fig. 023 		80	130	370		
		100	150	370		

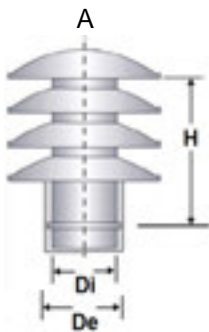
TERMINALE A ELEMENTI

FOTO	DISEGNO	Di	De	H	A	n. DISCHI
Fig. 024 		80	130	400	200	4
		100	150	400	220	4

TERMINALE DI SCARICO ORIZZONTALE

FOTO	DISEGNO	Di	De	H		
Fig. 029 		80	130	250		
		100	150	250		

RACCORDO TERMINALE CON PRESE ARIA

FOTO	DISEGNO	Di	De	H	A= M o F	B= M o F	
Fig. 040 		80	130	130	80	80/130	
		100	150	130	100	100/150	

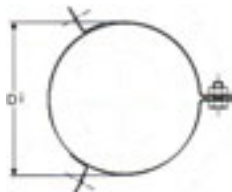

FASCETTA CAVI TIRANTI

FOTO	DISEGNO	Per Diametro	Di	H			
Fig. MPIIF063130 		80	130	30			
		100	150	30			

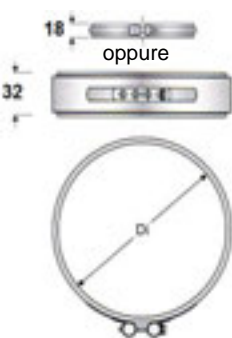
FASCETTA DI BLOCCAGGIO

FOTO	DISEGNO	Per Diametro	Di	H	H		
MPIIF051 ___ DPIIF034 ___ 		80	130	18	32		
		100	150	18	32		



GUARNIZIONE IN SILICONE

FOTO	DISEGNO	Di	H				
MPIIF053080 		80	95				
		100	95				

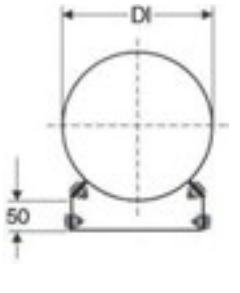
FASCETTA MURALE FISSA 50mm

FOTO	DISEGNO	Per Diametro	Di	H			
Fig. DPIIF0470 ___ 		80	130	50			
		100	150	50			

COPPIA PROLUNGHE PER STAFFA MURALE

FOTO	DISEGNO	L	H				
Fig. DPIIF054000 Fig. DPIIF055000 		300	40				
		400	40				

FASCETTA MURALE REGOLABILE 50/80 mm

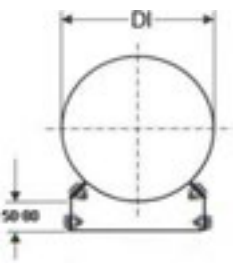
FOTO	DISEGNO	Per Diametro	Di	H			
Fig. DPIIF049 ___ 		80	130	50 - 80			
		100	150	50 - 80			

con la prolunga
cod. DPIIF054001
lo spostamento può arrivare
fino a 240mm

COPPIA PROLUNGHE PER STAFFA MURALE REGOLABILE

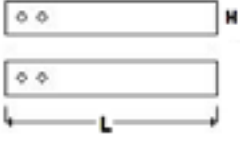
FOTO	DISEGNO	L	H				
Fig. DPIIF054001 		300	40				

FALDALE PIANO CON BASE IN PIOMBO

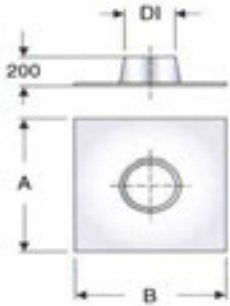
FOTO	DISEGNO	Per Diametro	Di	A	B		
Fig. 050 		80	160	1000	700		
		100	150	1000	700		

FALDALE INCLINATO CON BASE IN PIOMBO

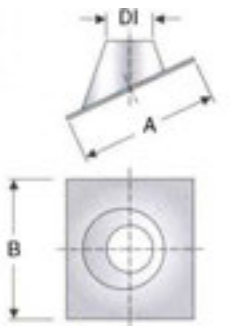
FOTO	DISEGNO	Per Diametro	Di	A	B		
Fig. 051 		80	160	1000	700		
		100	150	1000	700		

SCOSSALINA X FALDALE

FOTO	DISEGNO	Per Diametro	Di	H	A		
Fig. 055 		80	130	110	230		
		100	150	110	250		

Tutte le misure riportate sono in millimetri e con una possibile tolleranza del 5%.

Le foto e le misure sono state prese dal prodotto "standard", in cui i bicchieri F.F. sono rivolti verso l'alto.

Ci riserviamo di apportare modifiche al presente catalogo senza preavviso

Triveneta Fumi srl

Via Pacinotti, 19
PIOMBINO DESE (PD)
Tel.049/9368052
Fax.049/9367574
www.trivenetafumi.it
Email: info@trivenetafumi.it

Agente di zona:

