

CATALOGO TECNICO

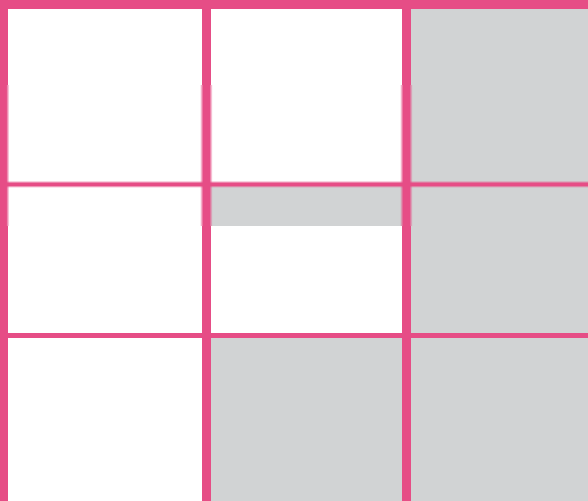

DOPPIA PARETE
ISOLATO AD ARIA

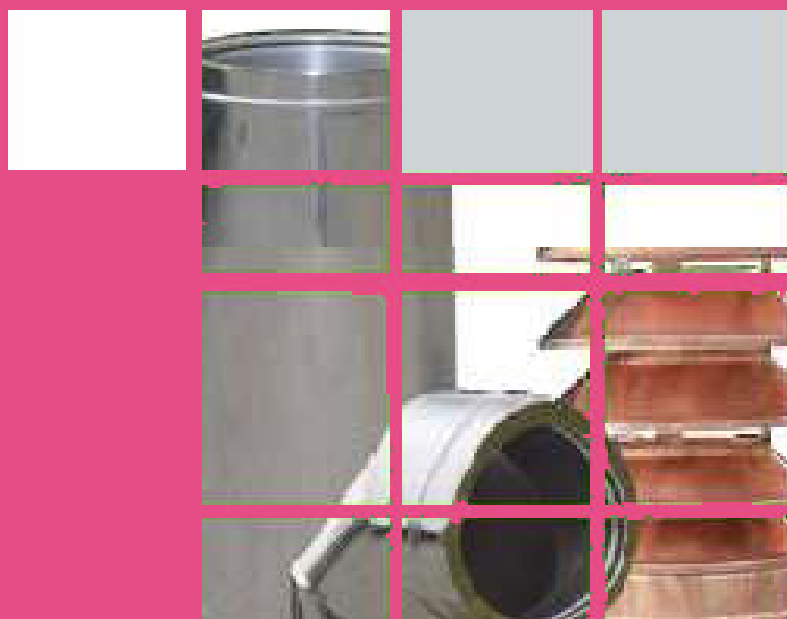



TRIVENETA FUMI





ELEMENTO LINEARE H=1000

FOTO	DISEGNO	Di	De	HT	H	
Fig. 001 		80	100	1000	940	
		100	120	1000	940	
		130	150	1000	940	
		160	180	1000	940	
		180	200	1000	940	
		200	220	1000	940	
		250	270	1000	940	
		300	320	1000	940	

ELEMENTO LINEARE H=500

FOTO	DISEGNO	Di	De	HT	H	
Fig. 003 		80	100	500	440	
		100	120	500	440	
		130	150	500	440	
		160	180	500	440	
		180	200	500	440	
		200	220	500	440	
		250	270	500	440	
		300	320	500	440	

ELEMENTO LINEARE H=250

FOTO	DISEGNO	Di	De	HT	H	
Fig. 005 		80	100	250	190	
		100	120	250	190	
		130	150	250	190	
		160	180	250	190	
		180	200	250	190	
		200	220	250	190	
		250	270	250	190	
		300	320	250	190	

ELEMENTO TELESCOPICO 245/375

FOTO	DISEGNO	Di	De	H Chiuso	H Aperto	
Fig. 007 		80	100	245	375	
		100	120	245	375	
		130	150	245	375	
		160	180	245	375	
		180	200	245	375	
		200	220	245	375	
		250	270	245	375	
		300	320	245	375	

ELEMENTO A "T" 90° con stacco DOPPIA PARETE

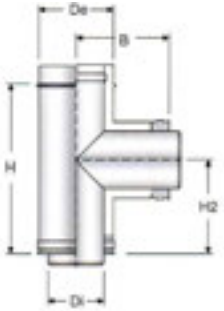
FOTO	DISEGNO	Di	De	H	H2	B
Fig. 011 		80	100	270	162	125
		100	120	270	162	135
		130	150	270	162	150
		160	180	445	250	165
		180	200	445	250	175
		200	220	445	250	185
		250	270	445	250	210
		300	320	445	250	235

ELEMENTO A "T" 90° con stacco MONO PARETE

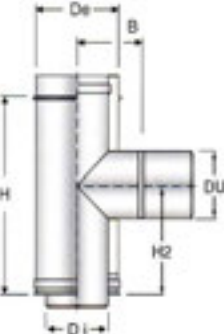
FOTO	DISEGNO	Di	De	H	H2	B
Fig. 012 		80	100	270	162	70
		100	120	270	162	80
		130	150	270	162	95
		160	180	445	250	110
		180	200	445	250	120
		200	220	445	250	130
		250	270	445	250	155
		300	320	445	250	180

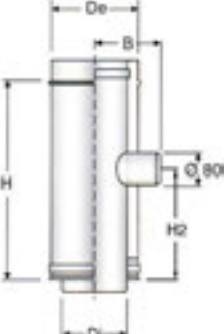

ELEMENTO A "T" 90° con stacco RIDOTTO A 80 MONO PARETE

FOTO	DISEGNO	Di	De	H	H2	B
Fig. 013 		-	-	-	-	-
		100	120	270	162	80
		130	150	270	162	95
		160	180	270	162	110
		180	200	270	162	120
		200	220	270	162	130
		250	270	270	162	155
		300	320	270	162	180

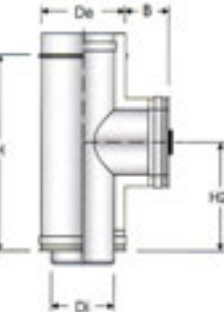
ELEMENTO DI ISPEZIONE

FOTO	DISEGNO	Di	De	H	H2	B
Fig. 015 		80	100	270	162	10
		100	120	270	162	10
		130	150	270	162	10
		160	180	270	162	10
		180	200	270	162	10
		200	220	270	162	10
		250	270	270	162	10
		300	320	270	162	10

ELEMENTO PRELIEVO FUMI CON TERMOMETRO

FOTO	DISEGNO	Di	De	H	HT	
Fig. 017 		80	100	440	500	
		100	120	440	500	
		130	150	440	500	
		160	180	440	500	
		180	200	440	500	
		200	220	440	500	
		250	270	440	500	
		300	320	440	500	

CURVA A 30°

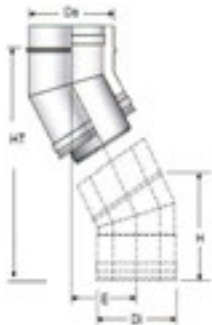
FOTO	DISEGNO	Di	De	H	HT	E
Fig. 021 		80	100	110	229	62
		100	120	117	244	65
		130	150			
		160	180			
		180	200			
		200	220			
		250	270			
		300	320			

CURVA A 45°

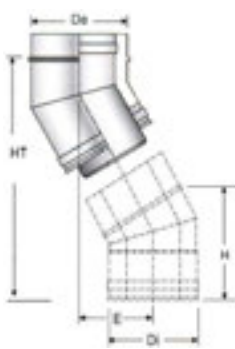
FOTO	DISEGNO	Di	De	H	HT	E
Fig. 022 		80	100	141	242	95
		100	120	156	244	100
		130	150	170	267	110
		160	180			
		180	200			
		200	220			
		250	270			
		300	320			

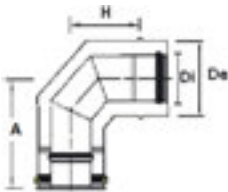

CURVA A 90°

FOTO	DISEGNO	Di	De	H	A	spost. asse 2x90
Fig. 023 		80	100	120	170	300
		100	120	120	170	300
		130	150			
		160	180			
		180	200			
		200	220			
		250	270			
		300	320			

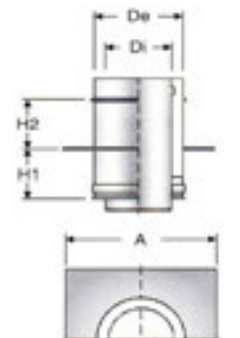
PIASTRA DI SUPPORTO INTERMEDIA

FOTO	DISEGNO	Di	De	H 1	H 2	A
Fig. 025 		80	100	90	35	200
		100	120	90	35	220
		130	150	90	35	250
		160	180	90	35	280
		180	200	90	35	300
		200	220	90	35	320
		250	270	90	35	370
		300	320	90	35	420

COPPIA ALETTE PER PIASTRA DI SUPPORTO INTERMED

FOTO	DISEGNO	Di	De	L		
MPIIF034 ___ 		80	100	200		
		100	120	220		
		130	150	250		
		160	180	280		
		180	200	300		
		200	220	320		
		250	270	370		
		300	320	420		

PIASTRA A TERRA CON SCARICO

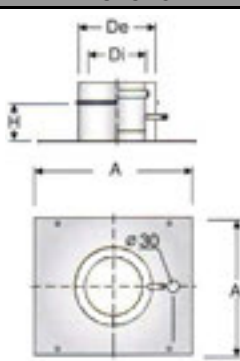
FOTO	DISEGNO	Di	De	H	A	
Fig. 027 		80	100	95	200	
		100	120	95	220	
		130	150	95	250	
		160	180	95	280	
		180	200	95	300	
		200	220	95	320	
		250	270	95	370	
		300	320	95	420	

ROSONE PIANO DI FINITURA

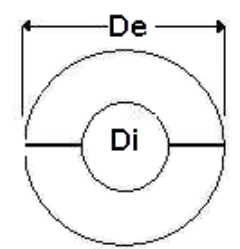
FOTO	DISEGNO	Per Diametro	Di	De		
MPIIF062 ___ 		80	100	200		
		100	120	220		
		130	150	250		
		160	180	280		
		180	200	300		
		200	220	320		
		250	270	370		
		300	320	420		

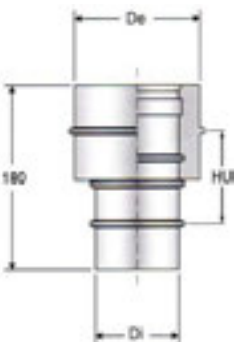

RACCORDO DA MONOPARETE A DOPPIA PARETE

FOTO	DISEGNO	Di	De	H U	H T	
Fig. 029  M ↑ senso fumi		80	100	70	180	
		100	120	70	180	
		130	150	70	180	
		160	180	70	180	
		180	200	70	180	
		200	220	70	180	
		250	270	70	180	
		300	320	70	180	

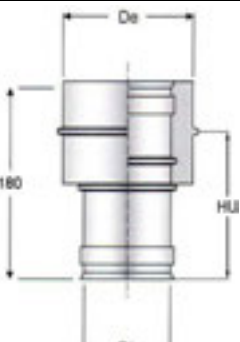

RACCORDO CALDAIA : DA MONOPARETE A DOPPIA PARETE

FOTO	DISEGNO	Di	De	H U	H T	
Fig. 030  F ↑ senso fumi		80	100	125	180	
		100	120	125	180	
		130	150	125	180	
		160	180	125	180	
		180	200	125	180	
		200	220	125	180	
		250	270	125	180	
		300	320	125	180	

RACCORDO DA DOPPIA PARETE A MONOPARETE

FOTO	DISEGNO	Di	De	H U	H T	
Fig. 031  F ↑ senso fumi		80	100	125	180	
		100	120	125	180	
		130	150	125	180	
		160	180	125	180	
		180	200	125	180	
		200	220	125	180	
		250	270	125	180	
		300	320	125	180	

FASCETTA CAVI TIRANTI

FOTO	DISEGNO	Per Diametro	Di	H		
Fig. 037  H		80	100	30		
		100	120	30		
		130	150	30		
		160	180	30		
		180	200	30		
		200	220	30		
		250	270	30		
		300	320	30		

TAPPO RACCOLTA CONDENSA

FOTO	DISEGNO	Di	De	H U		
Fig. 035 		80	100	20		
		100	120	20		
		130	150	20		
		160	180	20		
		180	200	20		
		200	220	20		
		250	270	20		
		300	320	20		

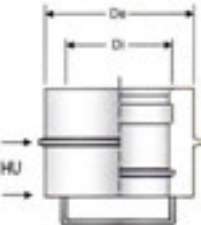

TAPPO CON MANIGLIA

FOTO	DISEGNO	Di	De	H U		
Fig. 036 		80	100	20		
		100	120	20		
		130	150	20		
		160	180	20		
		180	200	20		
		200	220	20		
		250	270	20		
		300	320	20		

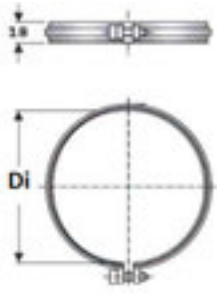
FASCETTA DI BLOCCAGGIO

FOTO	DISEGNO	Per Diametro	Di	H		
MPIIF051 _ _ _ 		80	100	18		
		100	120	18		
		130	150	18		
		160	180	18		
		180	200	18		
		200	220	18		
		250	270	18		
		300	320	18		

GUARNIZIONE IN SILICONE

FOTO	DISEGNO	Di	H			
MPIIF053 _ _ _ 		80	95			
		100	95			
		130	95			
		160	95			
		180	95			
		200	95			
		250	95			
		300	95			

TERMINALE ANTIVENTO

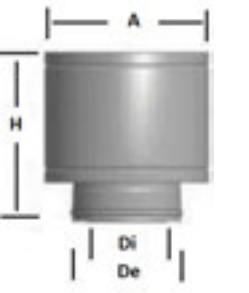
FOTO	DISEGNO	Di	De	H	A	
Fig. 039 		80	100	320	230	
		100	120	320	250	
		130	150			
		160	180			
		180	200			
		200	220			
		250	270			
		300	320			

TERMINALE PARAPIOGGIA

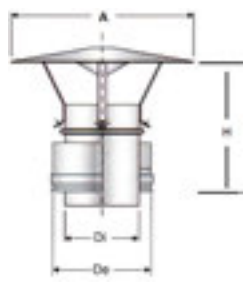
FOTO	DISEGNO	Di	De	H	A	
Fig. 041 		80	100	180	200	
		100	120	180	200	
		130	150			
		160	180			
		180	200			
		200	220			
		250	270			
		300	320			

TERMINALE TRONCO CONICO

FOTO	DISEGNO	Di	De	H		
Fig. 042 		80	100	190		
		100	120	190		
		130	150	190		
		160	180	190		
		180	200	190		
		200	220	190		
		250	270	190		
		300	320	190		

TERMINALE A ELEMENTI

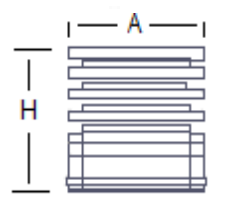
FOTO	DISEGNO	Di	De	H	A	n. DISCHI	
Fig. 044 		80	100	180	130	3	
		100	120	215	150	4	
		130	150	220	180	4	
		160	180	230	230	4	
		180	200	270	230	5	
		200	220	270	250	5	

FASCETTA MURALE FISSA 50mm

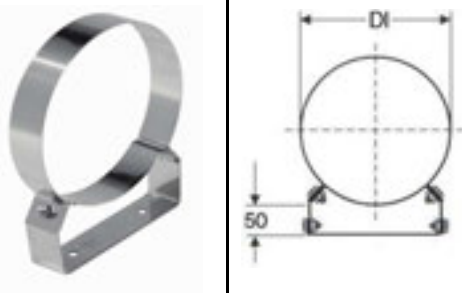
FOTO	DISEGNO	Per Diametro	Di	H		
Fig. 047 		80	100	50		
		100	120	50		
		130	150	50		
		160	180	50		
		180	200	50		
		200	220	50		
		250	270	50		
		300	320	50		

COPPIA PROLUNGHE PER STAFFA MURALE

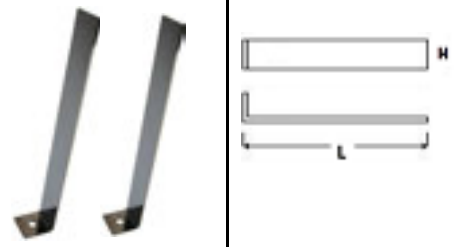
FOTO	DISEGNO	L	H				
Fig. DPIIF054000 Fig. DPIIF055000 		300	40				
		400	40				

FASCETTA MURALE REGOLABILE 50/80 mm

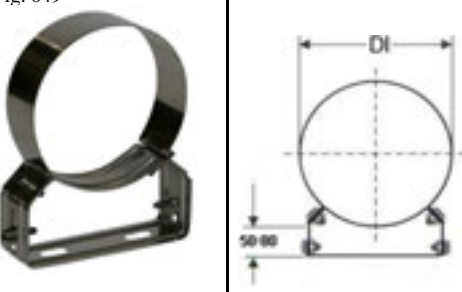
FOTO	DISEGNO	Per Diametro	Di	H		
Fig. 049 		80	100	50 - 80		
		100	120	50 - 80		
		130	150	50 - 80	con la prolunga cod. DPIIF054001 lo spostamento può arrivare fino a 240mm	
		160	180	50 - 80		
		180	200	50 - 80		
		200	220	50 - 80		
		250	270	50 - 80		
		300	320	50 - 80		

COPPIA PROLUNGHE PER STAFFA MURALE REGOLABILE

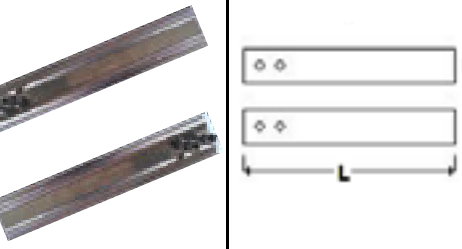
FOTO	DISEGNO	L	H				
Fig. DPIIF054001 		300	40				

FALDALE PIANO CON BASE IN PIOMBO

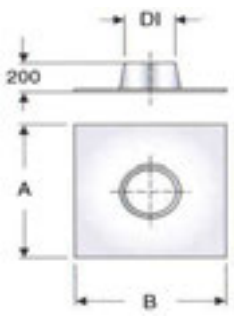
FOTO	DISEGNO	D	Di	A	B	
Fig. 050 		80	120	1000	700	
		100	170	1000	700	
		130	170	1000	700	
		160	220	1000	700	
		180	220	1000	700	
		200	270	1000	800	
		250	330	1000	800	
		300	330	1000	800	

FALDALE INCLINATO CON BASE IN PIOMBO

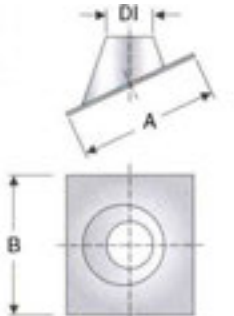
FOTO	DISEGNO	D	Di	A	B	
Fig. 051 		80	120	1000	700	
		100	170	1000	700	
		130	170	1000	700	
		160	220	1000	700	
		180	220	1000	700	
		200	270	1000	800	
		250	330	1000	800	
		300	330	1000	800	

SCOSSALINA X FALDALE

FOTO	DISEGNO	Per Diametro	Di	H	A	
Fig. 055 		80	100	110	200	
		100	120	110	220	
		130	150	110	250	
		160	180	110	280	
		180	200	110	300	
		200	220	110	320	
		250	270	110	370	
		300	320	110	420	

FOTO	DISEGNO	Di	De	H	A	He
		80	100			
		100	120			
		130	150			
		160	180			
		180	200			
		200	220			
		250	270			
		300	320			

Tutte le misure riportate sono in millimetri e con una possibile tolleranza del 5%.
Ci riserviamo di apportare modifiche al presente catalogo senza preavviso

Triveneta Fumi srl

Via Pacinotti, 19
PIOMBINO DESE (PD)
Tel.049/9368052
Fax.049/9367574
www.trivenetafumi.it
Email: info@trivenetafumi.it

Agente di zona:

